

Please note that the data given here has been taken from the online catalog. For comprehensive information and data, please refer to the user documentation at <http://www.download.phoenixcontact.com>. The General Terms and Conditions of Use apply to Internet downloads.

## ► Extract from the online catalog

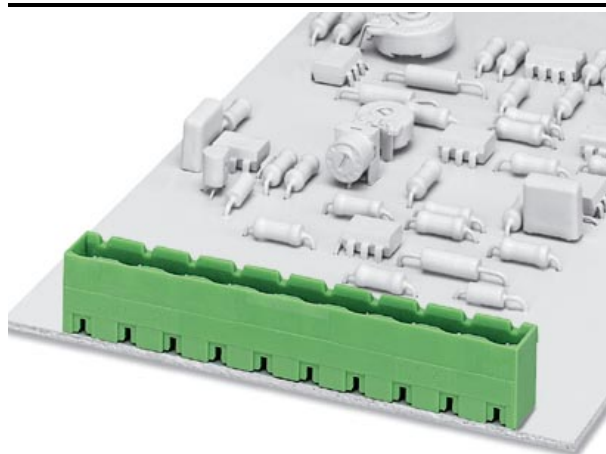

Header, nominal current: 12 A, rated voltage: 400 V, pitch: 7.5 mm, no. of positions: 8, mounting: Soldering

The illustration shows a 9-position version

Order No.	1766725
Ord designation	GMSTBVA 2,5/ 8-G
EAN	4017918032746
Pack	50 Pcs.
Customs tariff	85369010
Catalog page information	Page 191 (CC-2005)

## ► Technical data

### Dimensions / positions

Pitch	7.5 mm
Dimension a	52.5 mm
Number of positions	8
Pin dimensions	1 x 1 mm
Hole diameter	1.4 mm

**Technical data**

---

Insulating material group	I
Rated surge voltage (III/3)	6 kV
Rated surge voltage (III/2)	6 kV
Rated surge voltage (II/2)	6 kV
Rated voltage (III/2)	400 V
Rated voltage (II/2)	1000 V
Connection in acc. with standard	EN-VDE
Nominal current $I_N$	12 A
Nominal voltage $U_N$	400 V
Maximum load current	12 A
Insulating material	PBT
Inflammability class acc. to UL 94	V0

---

---

## ► Certificates

---

### Certificate logos



---

#### UL

Nominal voltage $U_N$	300 V
Nominal current $I_N$	10 A

---

#### CSA

Nominal voltage $U_N$	300 V
Nominal current $I_N$	10 A

---

## ► Drawings

Drilling diagram

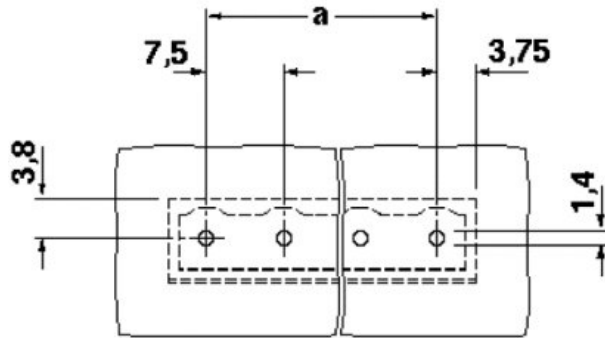

Dimensioned drawing

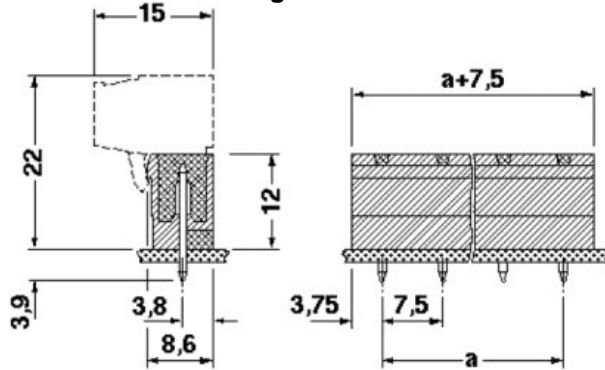

---

**► Accessories**

---

Item	Designation	Description
<b>Assembly</b>		
1755477	MSTB-BL	Keying cap, for forming sections, plugs onto header pin, green insulating material
<b>Marking</b>		
0804455	SK 7,5/3,8:FORTL.ZAHLEN	Marker card, self-adhesive, 10-section marker strip, 10 identical decades marked 1-10, 11-20 etc. up to 91-100, sufficient for 100 terminal blocks
<b>Plug/Adapter</b>		
1734401	CR-MSTB	Coding element, inserted into the recess in the header or the inverted plug, red insulating material

---

---

**► Additional products**

---

Item	Designation	Description
<b>General</b>		
1766945	GMSTB 2,5/ 8-ST	Plug component, nominal current: 12 A, rated voltage: 500 V, pitch: 7.5 mm, no. of positions: 8, type of connection: Screw connection
1737767	GMVSTBR 2,5/ 8-ST	Plug component, nominal current: 12 A, rated voltage: 500 V, pitch: 7.5 mm, no. of positions: 8, type of connection: Screw connection
1737877	GMVSTBW 2,5/ 8-ST	Plug component, nominal current: 12 A, rated voltage: 500 V, pitch: 7.5 mm, no. of positions: 8, type of connection: Screw connection

---

## ► Address

---

PHOENIX CONTACT GmbH & Co. KG  
Flachsmarktstr. 8  
32825 Blomberg  
Germany  
Phone +49 5235 3 00  
Fax +49 5235 3 1200  
<http://www.phoenixcontact.com>  
Phoenix Contact  
Technical modifications reserved;